

P	LTR	DESCRIPTION	ECN	DATE	DRN	APVD
A		SAFETY STANDARD ADDITION		25-MAR-04	R. X	M. J.
B		ADD PACKAGE NOTE	FK00-0183-04	11-OCT-04	G. L.	M. J.

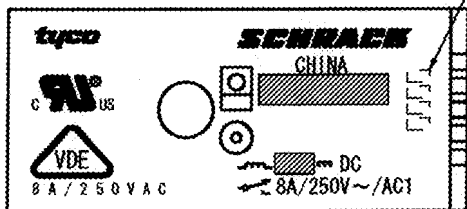

Lot No.

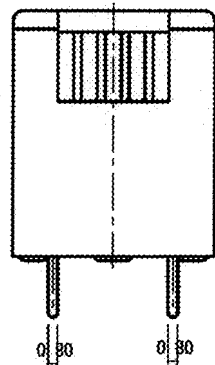
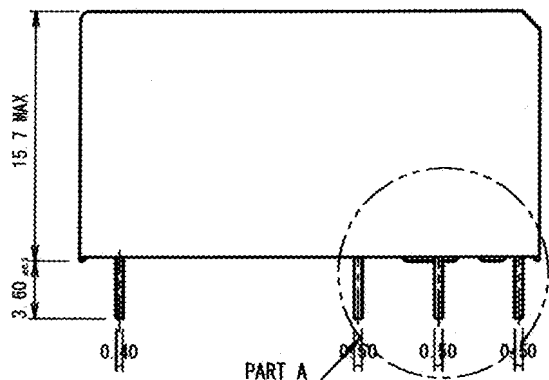

CONNECTION DIAGRAM (BOTTOM VIEW)

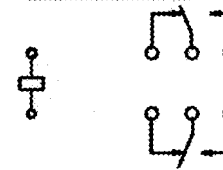

DRILLING DIAGRAM (BOTTOM VIEW)

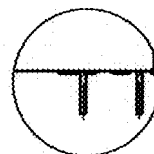
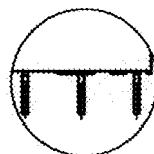
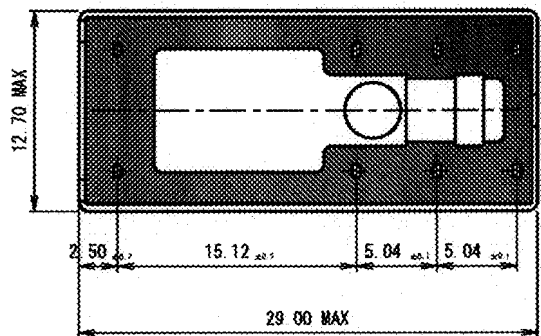
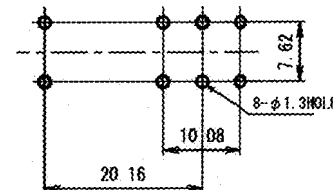

PART A

THIS DRAWING IS A CONTROLLED DOCUMENT FOR TYCO ELECTRONICS CORPORATION. IF IT IS SUBJECT TO CHANGE, THE CONTROLLING ENGINEERING ORGANIZATION SHOULD BE CONTACTED FOR THE LATEST REVISION.

DIMENSIONS:	UNITS	DR DIMS OR DIMS OTHERWISE SPECIFIED:
0 P.D.	±	
1 P.D.	±	
2 P.D.	±	
3 P.D.	±	
4 P.D.	±	
ANGLES	±	

MATERIAL: SEE MATERIAL TABLE. FINISH: N.P.

DRN	H. XIAO
CHK	I. FURUYA
APVD	M. J. HD
PRODUCT SPEC	
APPLICATION SPEC	
NET/GRY	
CUSTOMER DRAWING	

RT 2P 8A 5PIN CUSTOMER DRAWING	
SIZE	A3
CAGE CODE	00779
DRAWING NO.	1649329
RESTRICTED TO	
SCALE	3:1
SHEET	1 OF 4
REV	B

APVD BY SCHRACK: *Werk Walsdorf*
Dir. 1.3.2004
A. 1.3.2004
1.3.2004

Diagram dimension	Tolerance
作图尺寸	公差
0.99mm max	±0.1mm
1 - 2.99mm	±0.2mm
3mm min.	±0.3mm

THIS DRAWING IS UNPUBLISHED. RELEASED FOR PUBLICATION
 © COPYRIGHT BY TYCO ELECTRONICS CORPORATION. ALL RIGHTS RESERVED.

LDC	DIST	REVISIONS						
		P	LTR	DESCRIPTION	ECN	DATE	DWN	APVD
HH								

(B)

PACKAGE SPECIFICATION		
1816098-1	PLASTIC TUBE	20 PCS/TUBE
1816099-1	OUTSIDE CARTON BOX	25 TUBES/BOX

RELAY TYPE

PART NO	DESCRIPTION	ITEM
7-1649329-2	RT445110AP	72
7-1649329-1	RT445060AP	71
7-1649329-0	RT445048AP	70
6-1649329-9	RT445024AP	69
6-1649329-8	RT445018AP	68
6-1649329-7	RT445012AP	67
6-1649329-6	RT445009AP	66
6-1649329-5	RT445008AP	65
6-1649329-4	RT445008AP	64
6-1649329-3	RTE45110AP	63
6-1649329-2	RTE45080AP	62
6-1649329-1	RTE45048AP	61
6-1649329-0	RTE45024AP	60
5-1649329-9	RTE45018AP	59
5-1649329-8	RTE45012AP	58
5-1649329-7	RTE45008AP	57

PART NO	DESCRIPTION	ITEM
5-1649329-6	RTE45008AP	56
5-1649329-5	RTE45006AP	55
5-1649329-4	RT425110AP	54
5-1649329-3	RT425080AP	53
5-1649329-2	RT425048AP	52
5-1649329-1	RT425024AP	51
5-1649329-0	RT425018AP	50
4-1649329-9	RT425012AP	49
4-1649329-8	RT425009AP	48
4-1649329-7	RT425008AP	47
4-1649329-6	RT425005AP	46
4-1649329-5	RTE25110AP	45
4-1649329-4	RTE25080AP	44
4-1649329-3	RTE25048AP	43
4-1649329-2	RTE25024AP	42
4-1649329-1	RTE25018AP	41
4-1649329-0	RTE25012AP	40
3-1649329-9	RTE25008AP	39
3-1649329-8	RTE25006AP	38
3-1649329-7	RTE25005AP	37
3-1649329-6	RT444110AP	36
3-1649329-5	RT444080AP	35
3-1649329-4	RT444048AP	34
3-1649329-3	RT444024AP	33
3-1649329-2	RT444018AP	32
3-1649329-1	RT444012AP	31
3-1649329-0	RT444008AP	30
2-1649329-9	RT444006AP	29



PART NO	DESCRIPTION	ITEM
2-1649329-8	RT444005AP	28
2-1649329-7	RT444110AP	27
2-1649329-6	RTE44060AP	26
2-1649329-5	RTE44048AP	25
2-1649329-4	RTE44024AP	24
2-1649329-3	RTE44018AP	23
2-1649329-2	RTE44012AP	22
2-1649329-1	RTE44008AP	21
2-1649329-0	RTE44006AP	20
1-1649329-9	RTE44005AP	19
1-1649329-8	RT424110AP	18
1-1649329-7	RT424080AP	17
1-1649329-6	RT424048AP	16
1-1649329-5	RT424024AP	15
1-1649329-4	RT424018AP	14
1-1649329-3	RT424012AP	13
1-1649329-2	RT424009AP	12
1-1649329-1	RT424006AP	11
1-1649329-0	RT424005AP	10
1649329-9	RTE24110AP	9
1649329-8	RTE24080AP	8
1649329-7	RTE24048AP	7
1649329-6	RTE24024AP	6
1649329-5	RTE24018AP	5
1649329-4	RTE24012AP	4
1649329-3	RTE24008AP	3
1649329-2	RTE24006AP	2
1649329-1	RTE24005AP	1

(B)

(B)

(B)

THIS DRAWING IS A CONTROLLED DOCUMENT FOR TYCO ELECTRONICS CORPORATION. IT IS SUBJECT TO CHANGE AND THE CONTROLLING ENGINEERING ORGANIZATION SHOULD BE CONTACTED FOR THE LATEST REVISION.

DIMENSIONS: UNLESS OTHERWISE SPECIFIED: DIM		TOLERANCES UNLESS OTHERWISE SPECIFIED: 2 PLS ± 1 PLS ± 3 PLS ± 4 PLS ± ANGLES ±		DWN CHK			
		FINISH UNLESS OTHERWISE SPECIFIED		APVD		NAME S/C	
MATERIAL UNLESS OTHERWISE SPECIFIED		SEE MATERIAL TABLE		PROPERTY SPEC UNLESS OTHERWISE SPECIFIED		RT 2P 8A 5PIN CUSTOMER DRAWING	
				APPLICATION SPEC UNLESS OTHERWISE SPECIFIED		SIZE A3	
				WEIGHT		CAGE CODE 00779	
				CUSTOMER DRAWING		DRAWING NO 1649329	
						RESTRICTED TO	
						SCALE 3:1	
						SHEET 2 OF 4	
						REV B	

APVD BY SCHRACK: *Wolfgang Waidacher*
 40880 Waidacher
 30.03.2000

